

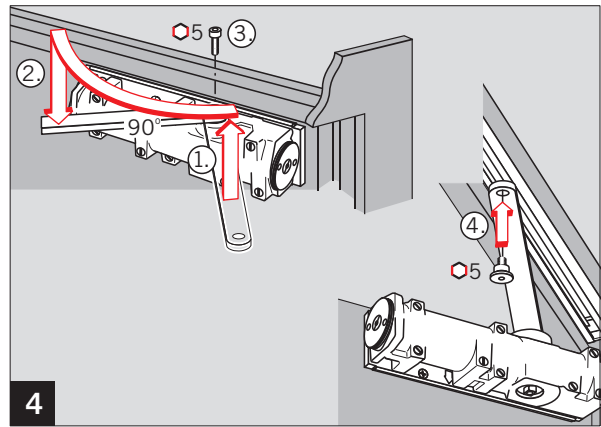

WN 056606 45532
04/06

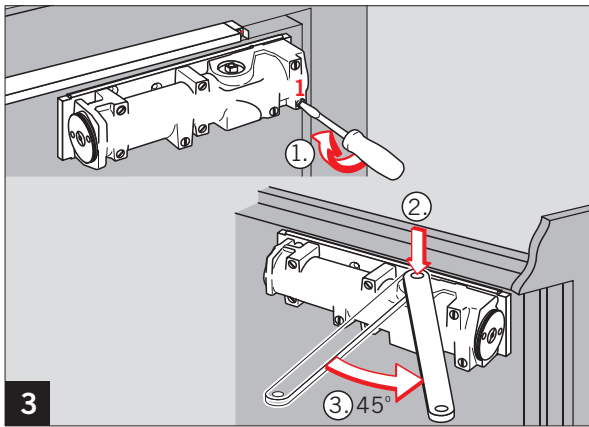

CE	DORMA GmbH + Co. KG	04
	Postfach 4009 58 247 Ennepetal	4 8 2-5 1 1 4 4 8 5-7 1 1 4
0432-BPR 0008 EN 1154:1996+A1:2002		Dangerous substances: None

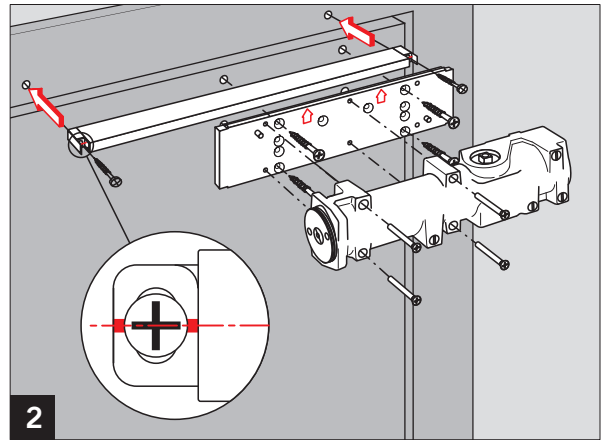
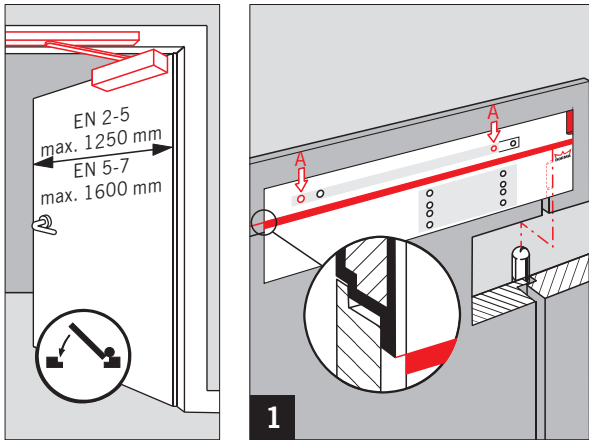
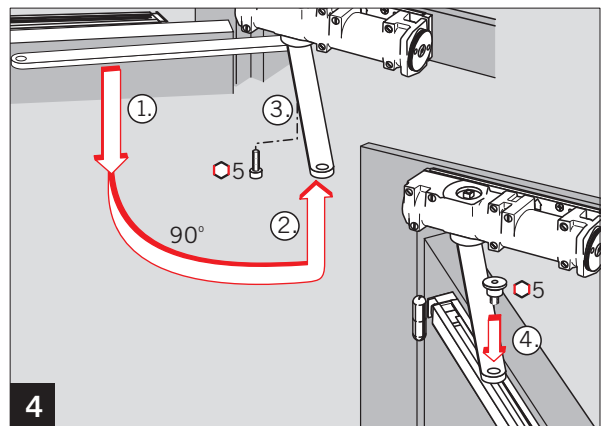
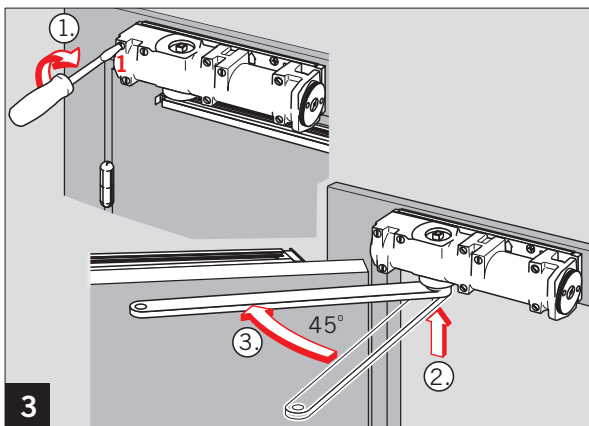
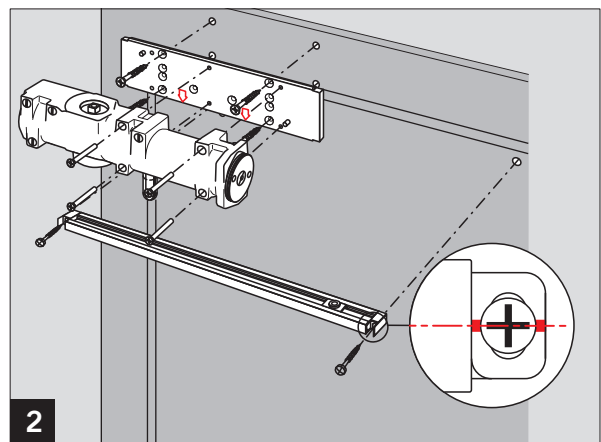
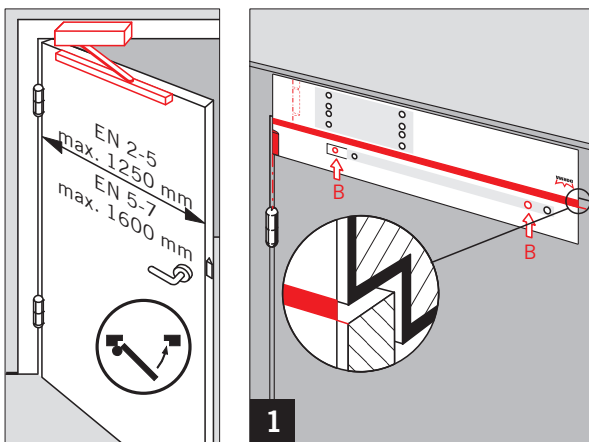

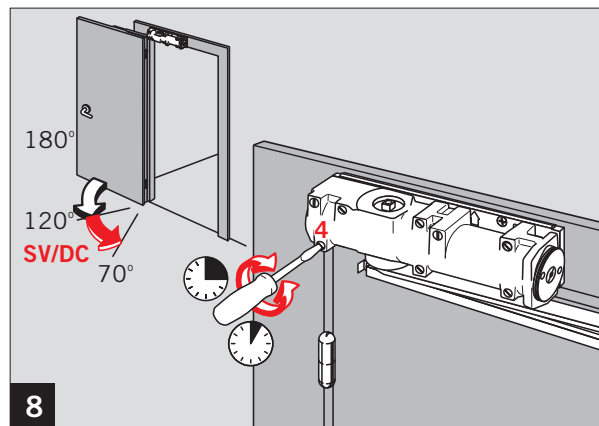
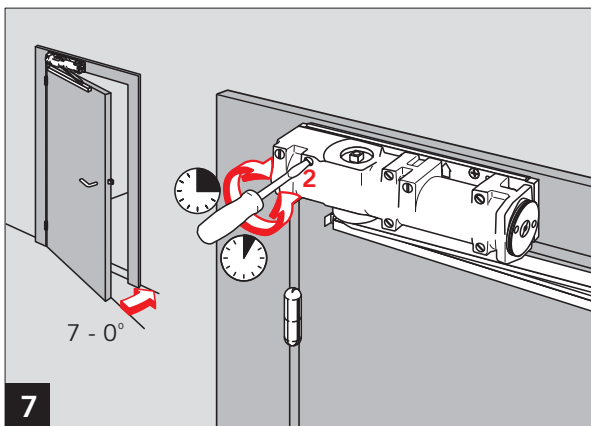
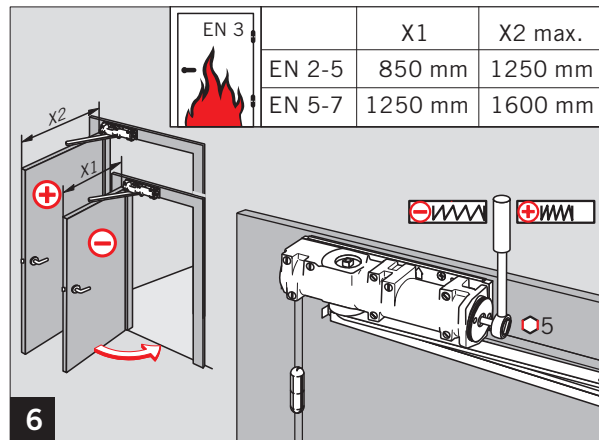
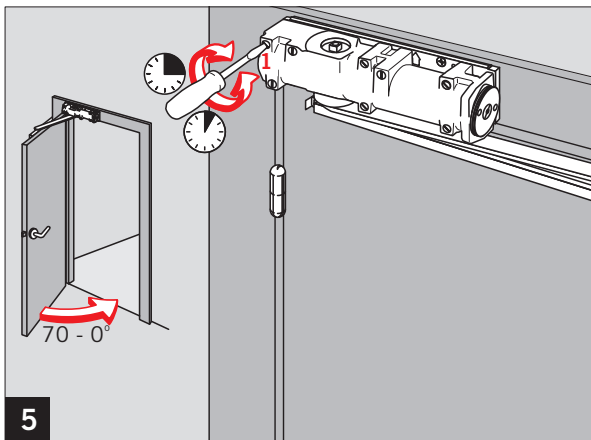
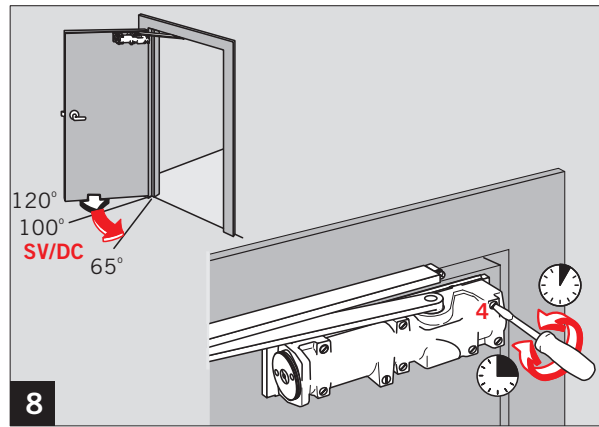
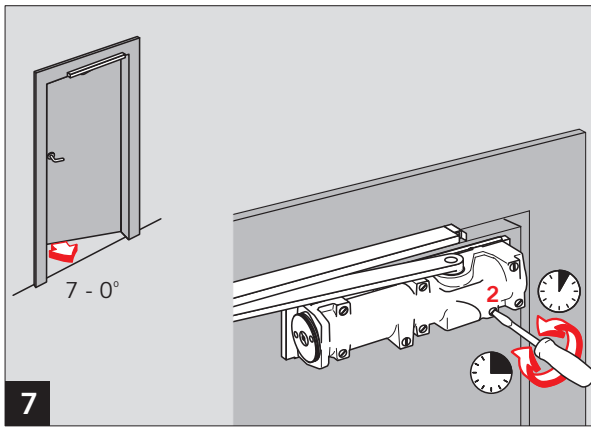
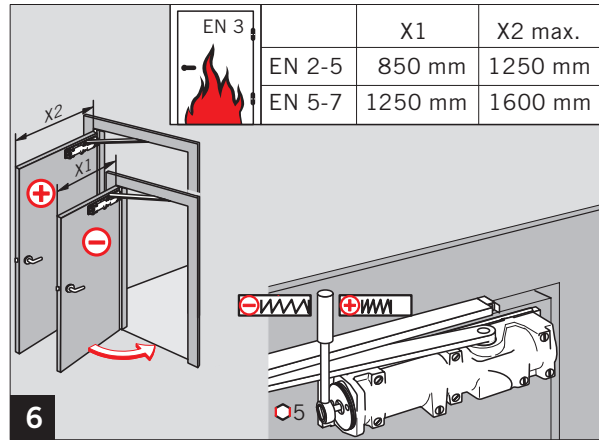
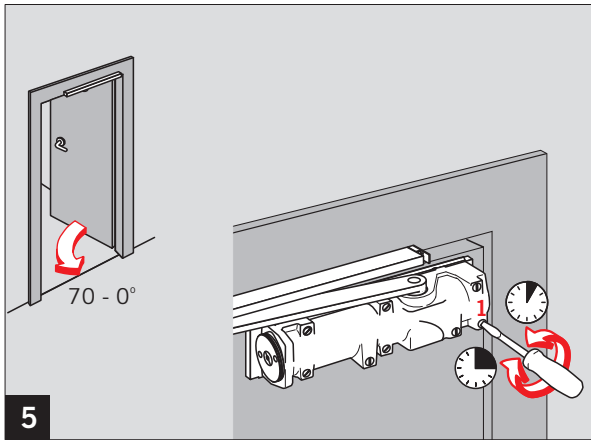

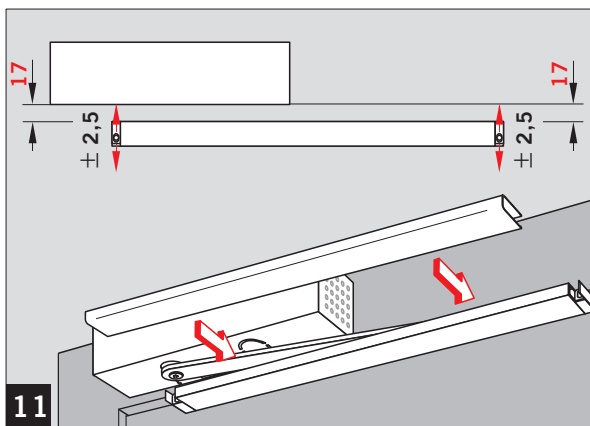
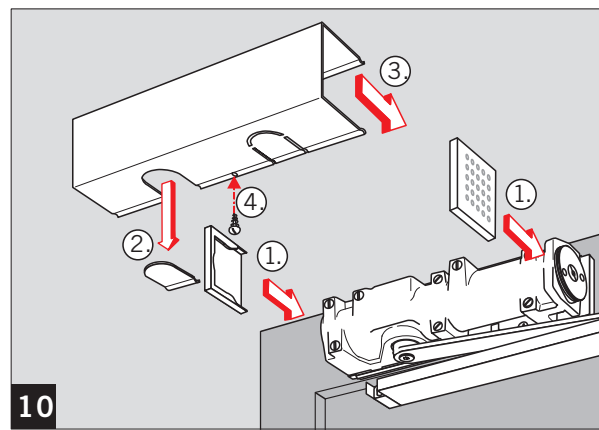
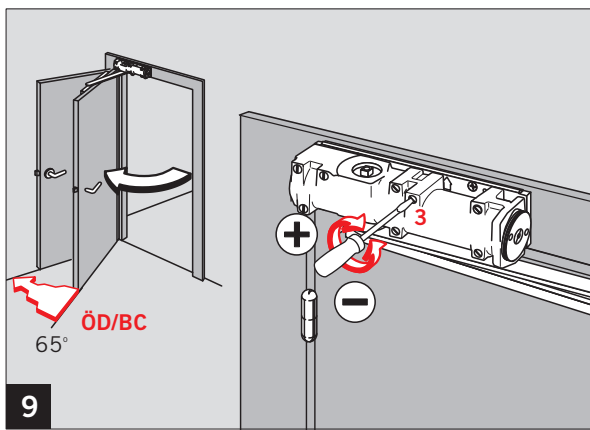
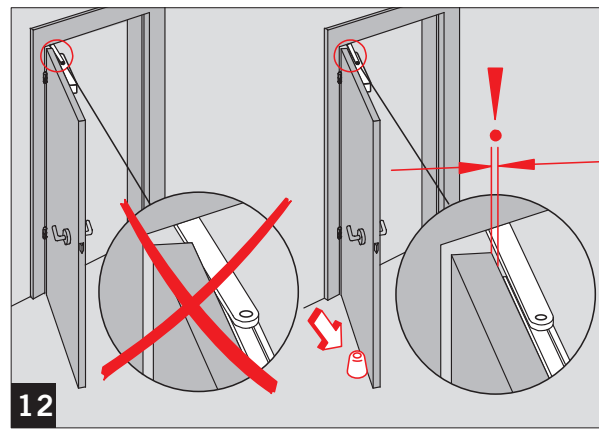
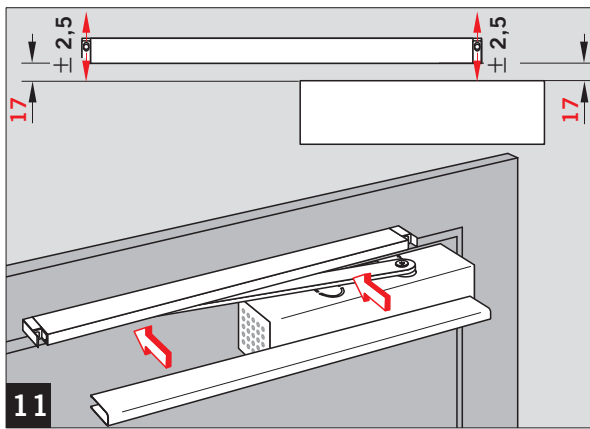
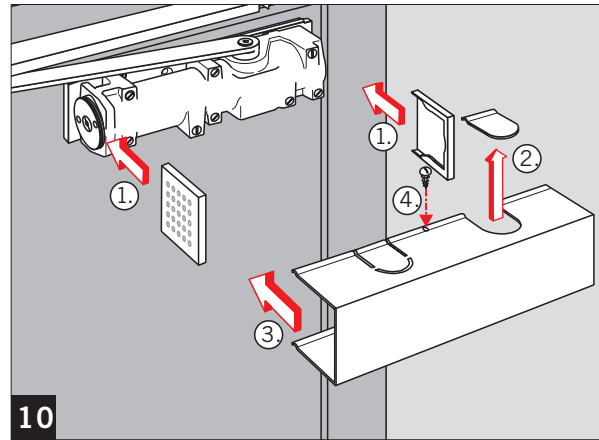
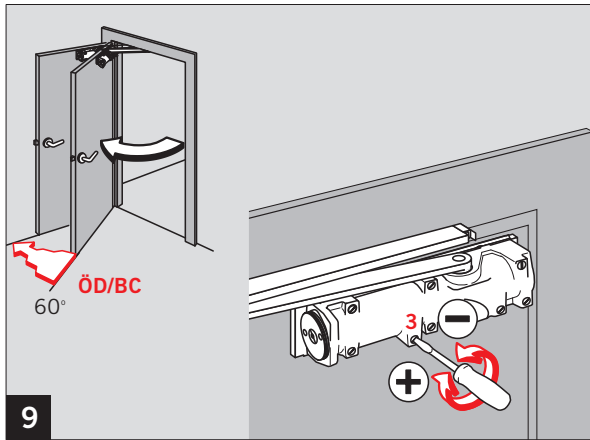

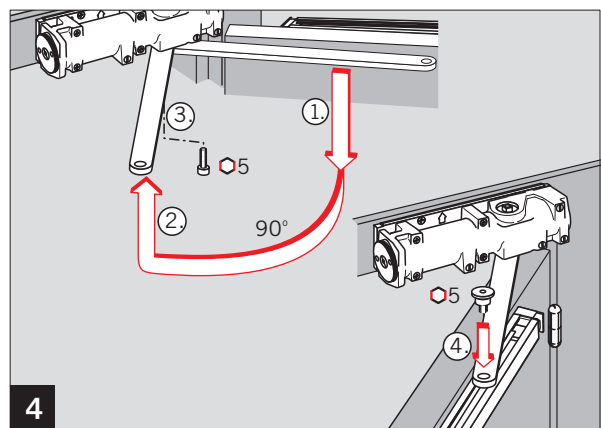
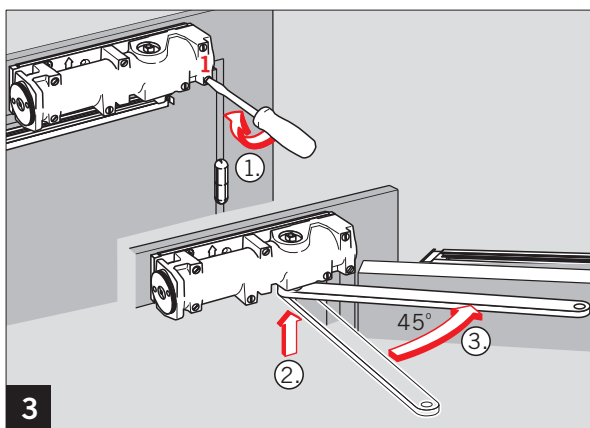
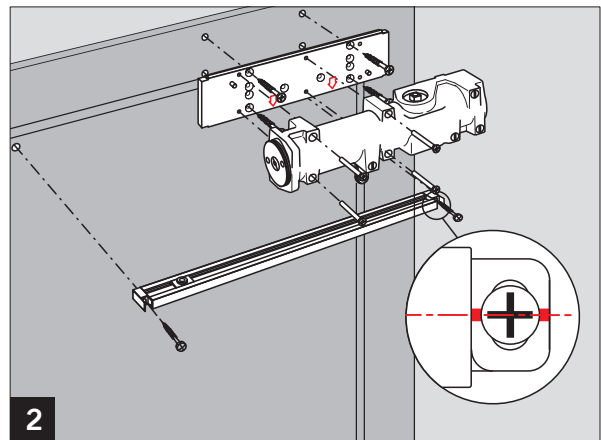
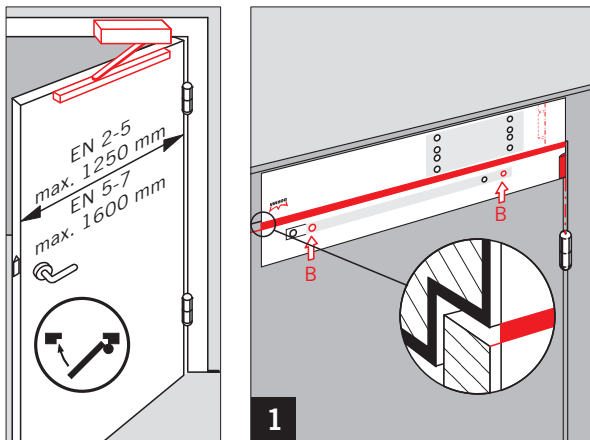
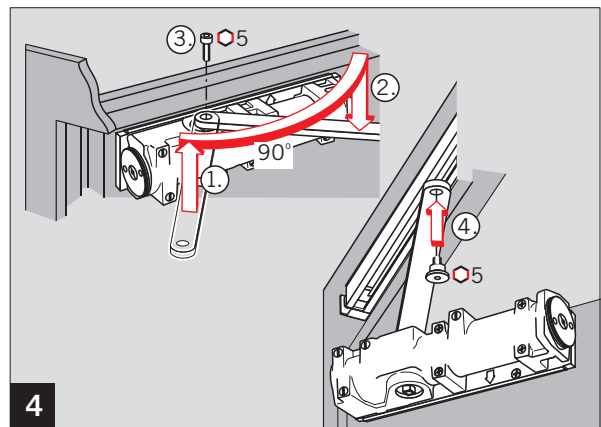
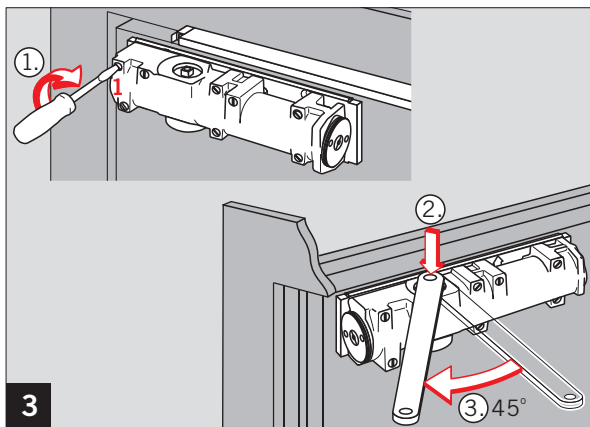
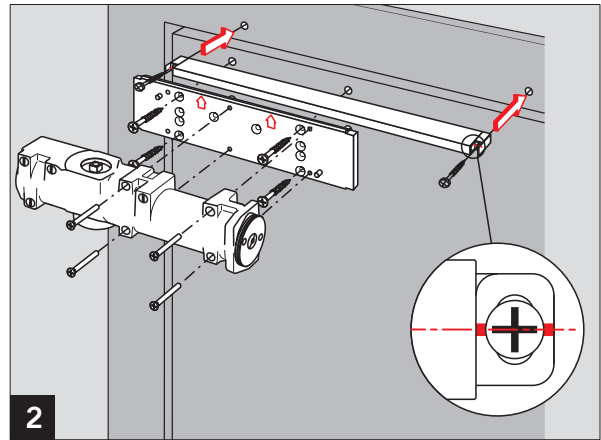
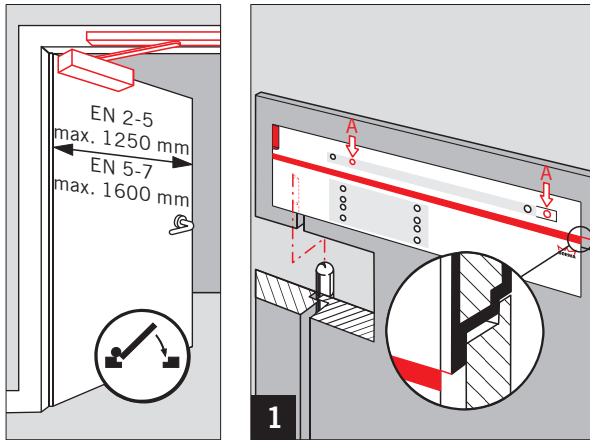

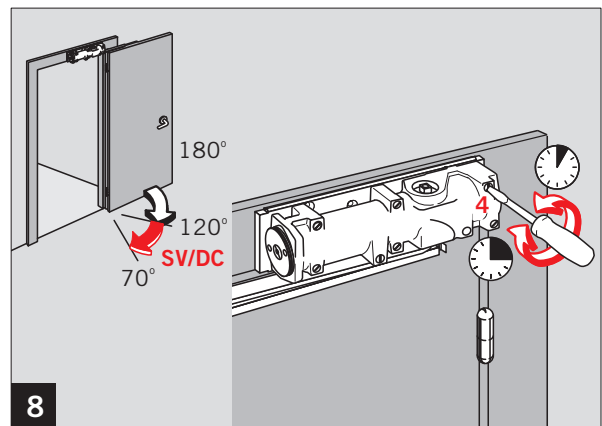
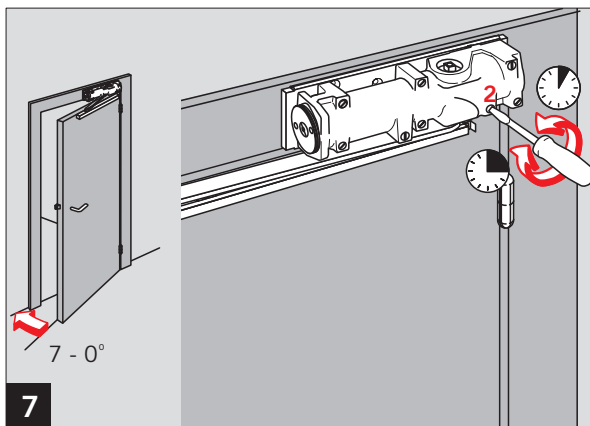
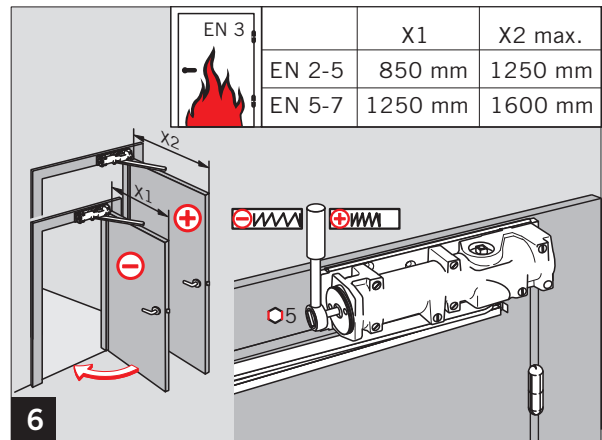
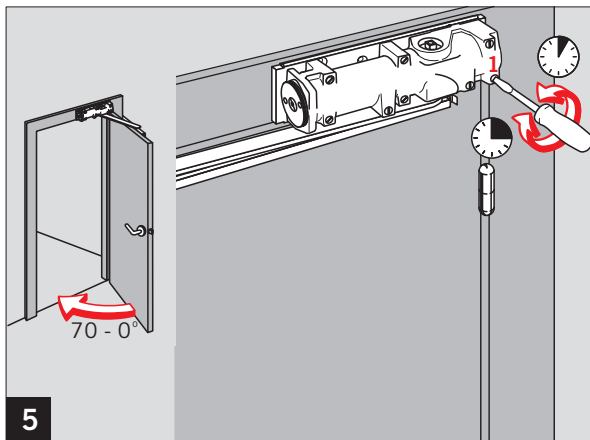
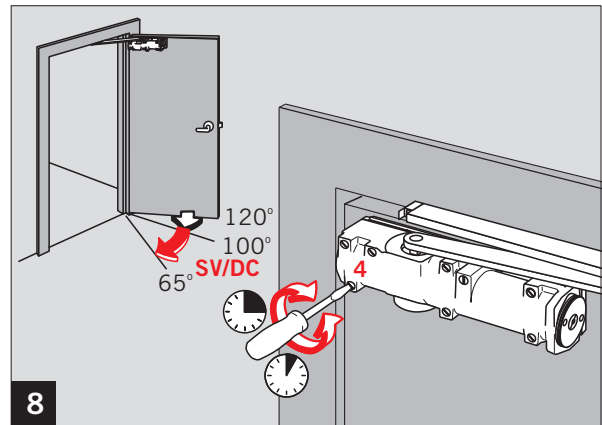
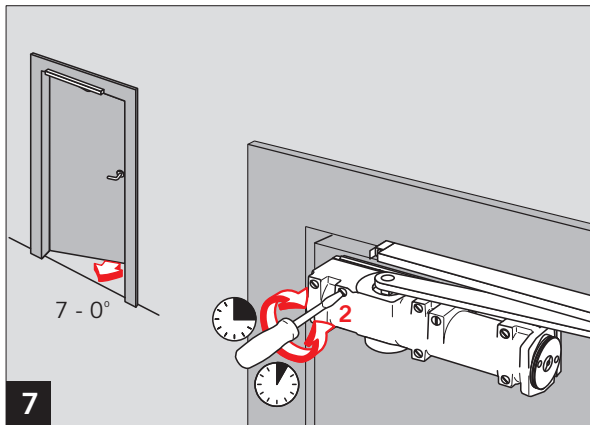
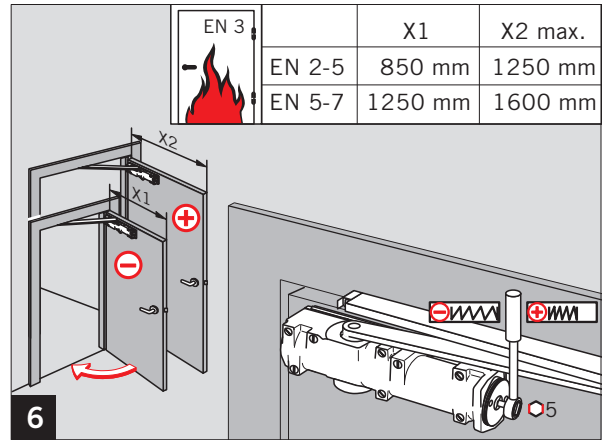
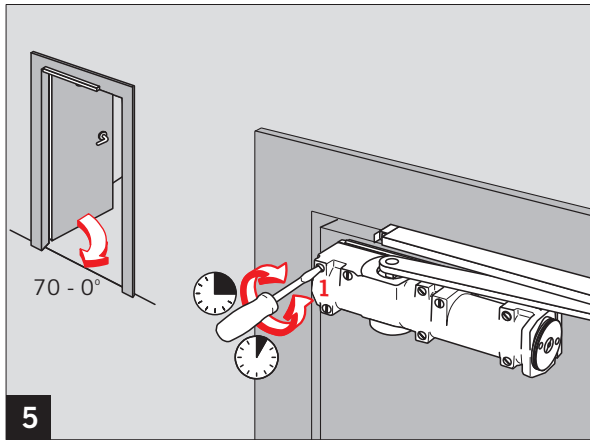

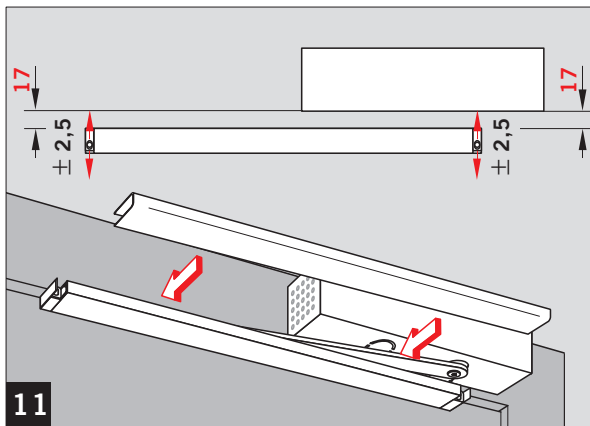
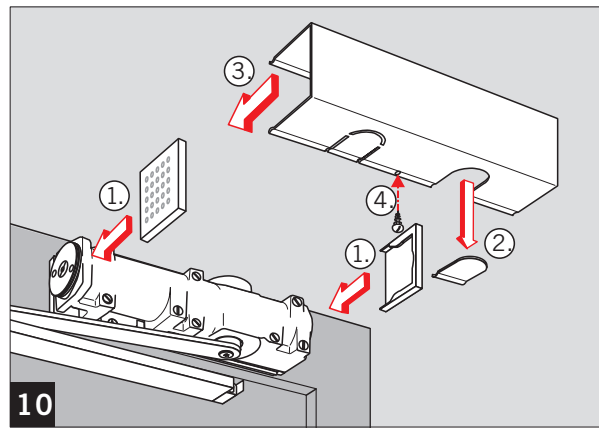
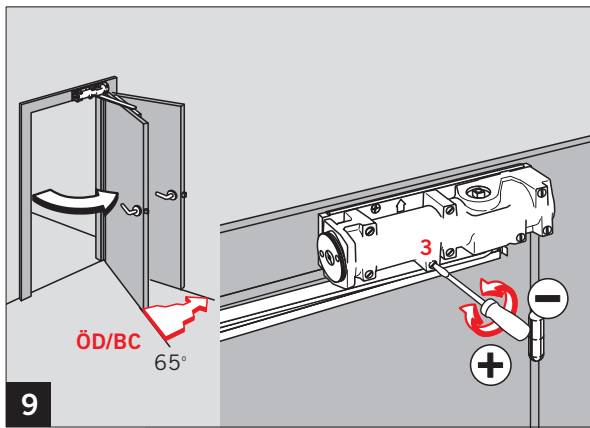
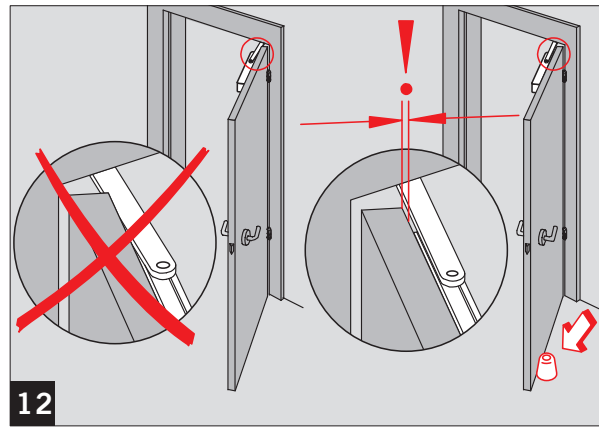
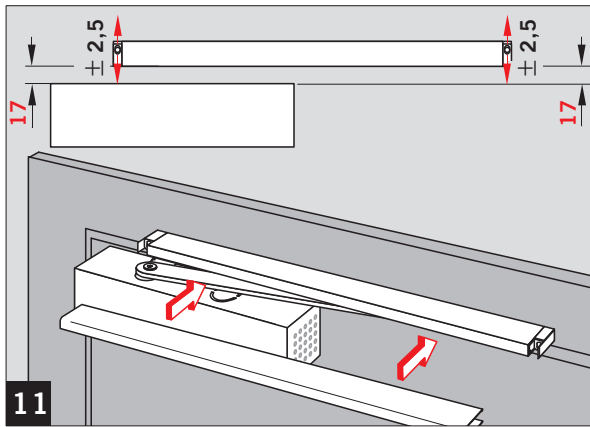
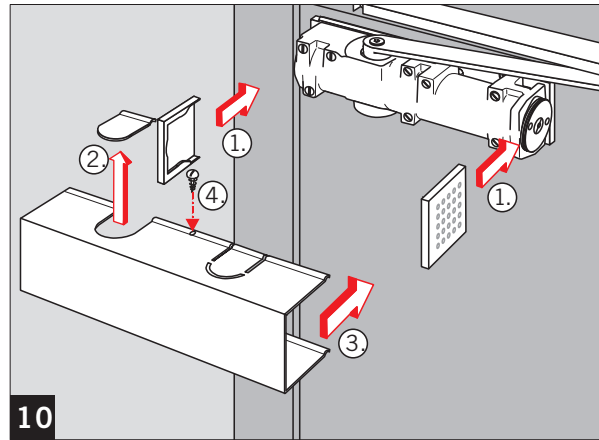
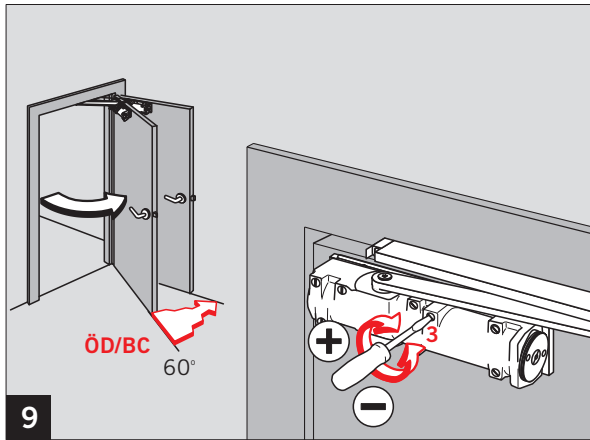

Änderungen vorbehalten
Subject to change without notice